

Instabilities Observations in magnetized plasmas : TORIX Experiment



Laboratoire de Physique des Plasmas

Practical Work 05/03/25

Cyrille Honoré

Laboratoire de Physique de Plasmas

CNRS – Sorbonne Univ. – UPSaclay – ObsParis,

École Polytechnique



Instabilities in magnetized plasmas

- Torix plasma "equilibrium"
- Drift wave instabilities
- Langmuir Probe Instability measurements
- High speed camera observations

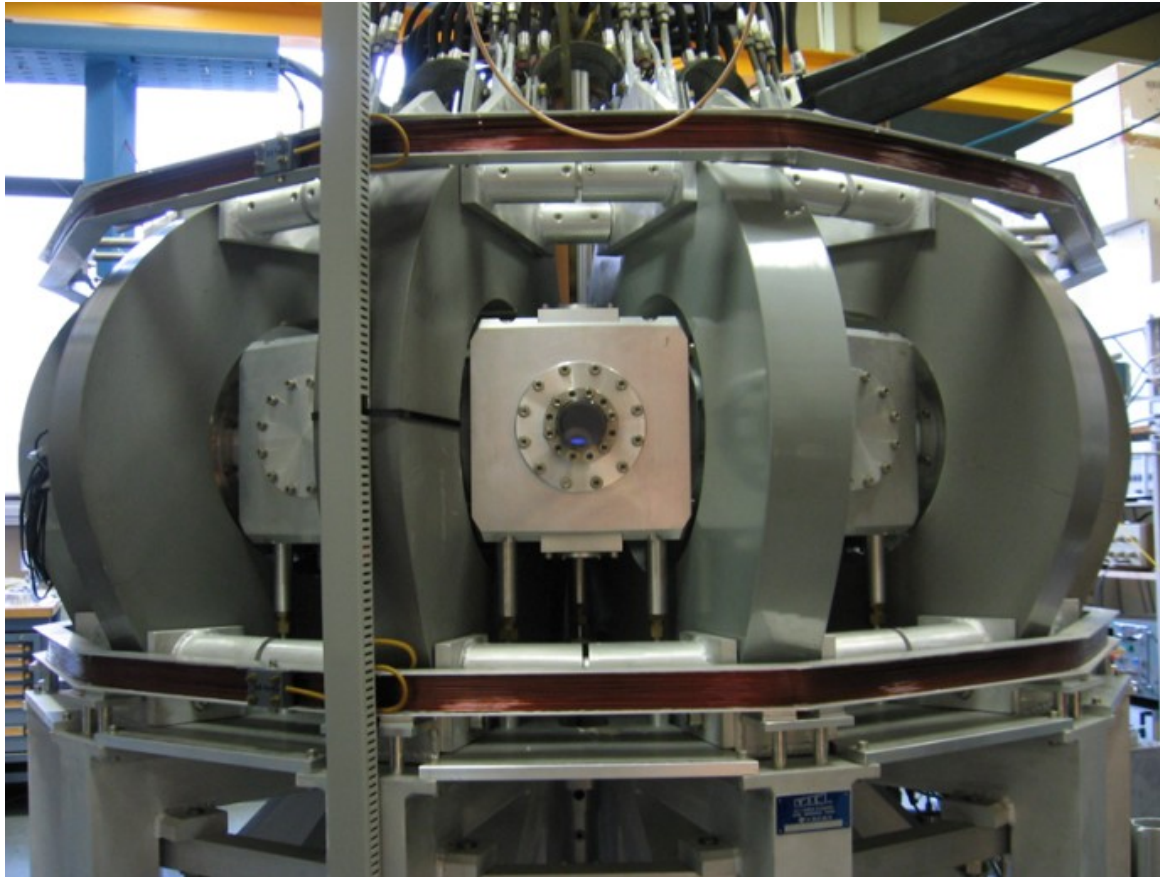

Torix : operation components and diagnostics

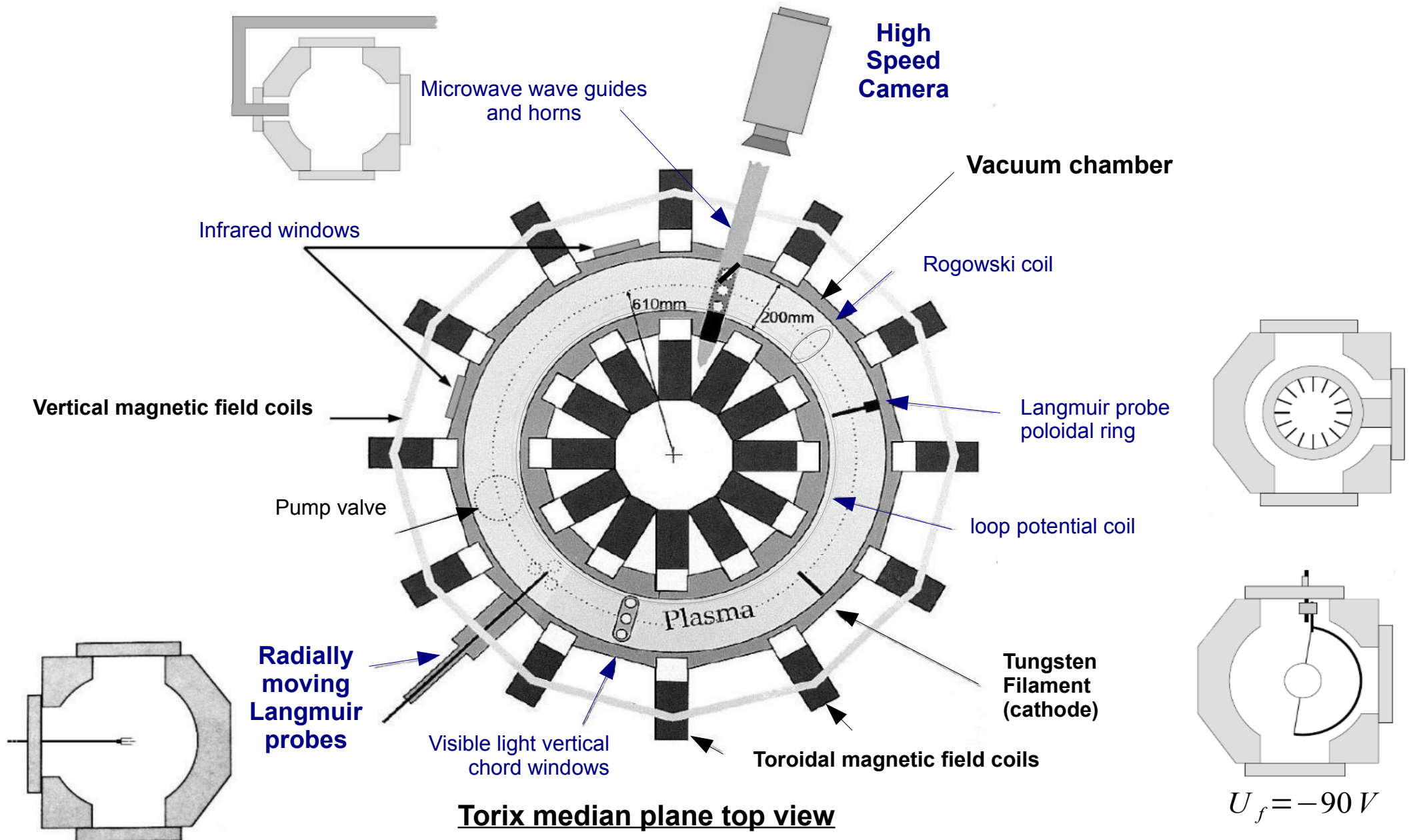

Toric geometry

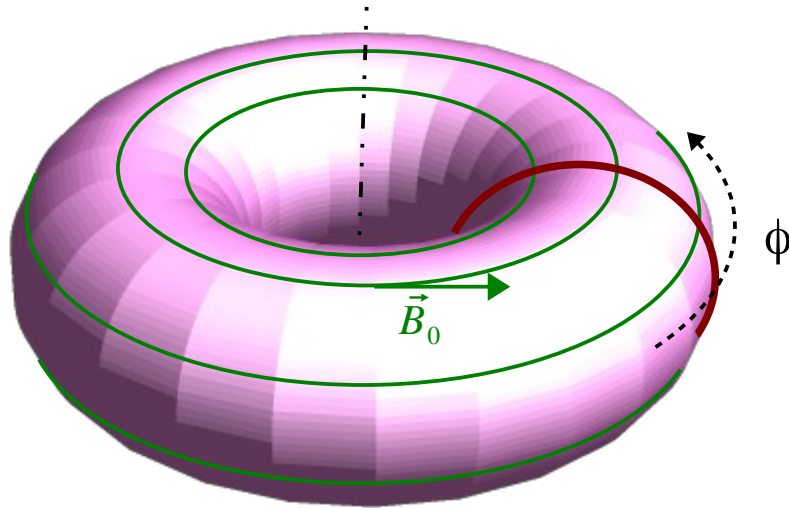

Poloidal section

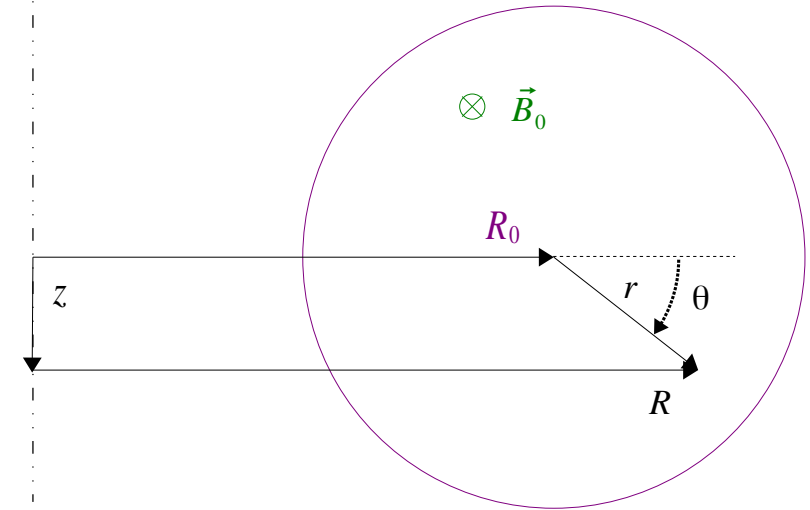

We use usual toric geometry coordinate system

ϕ : toroidal angle

Inside a poloidal section

R_0 : tore large radius

R : particle large radius

z : vertical coordinate

r : particle small radius

θ : poloidal angle

Magnetic field geometry

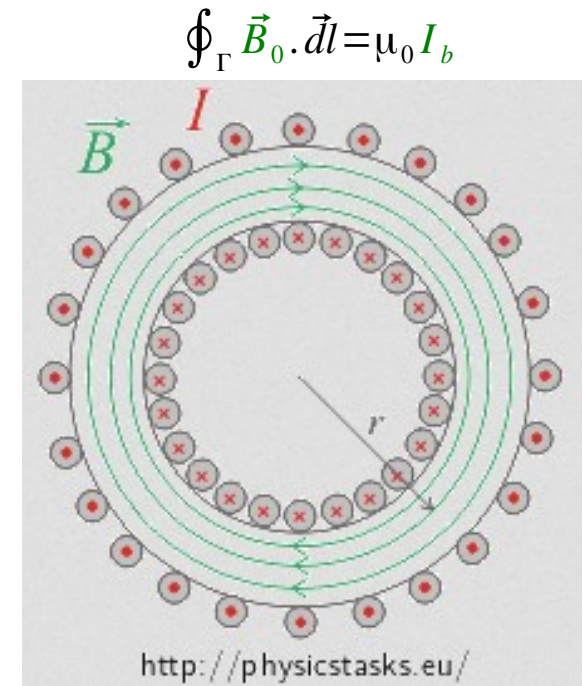
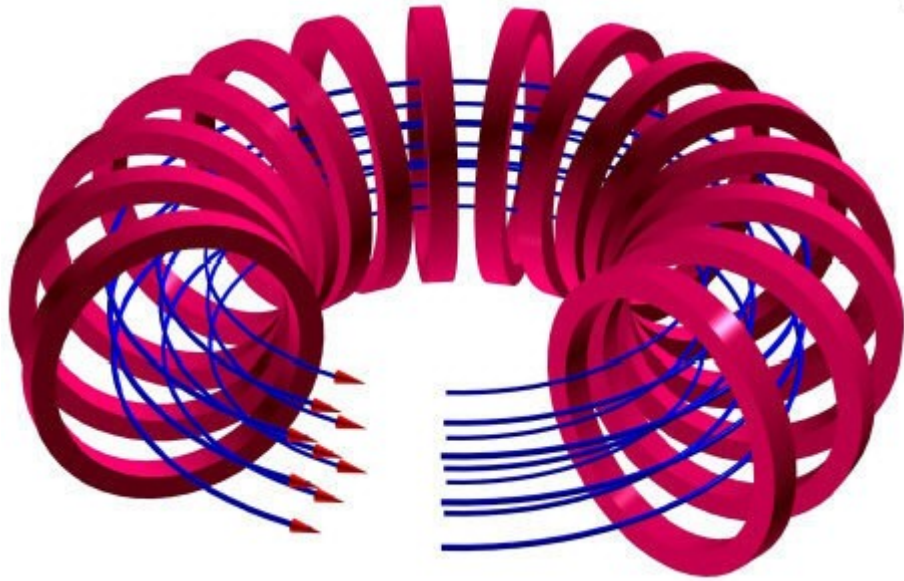

The main magnetic is created by coils around the torus device

The magnetic field lines are circular.

The magnetic field magnitude decreases with the large radius:

$$B_0 = \frac{\mu_0}{2\pi R} I_b$$

Toroidal magnetic field drifts

For a toric plasma, because of the magnetic field gradient and curvature, charged particles undergo vertical drifts, with opposite directions for opposite charge signs.

This creates a vertical charge separation that generates a secondary vertical electric field.

This vertical electrical field induces a plasma radially outward ExB drift:

$$\vec{u}_{E\alpha} = \frac{\vec{E}_y \wedge \vec{B}_0}{B_0^2}$$

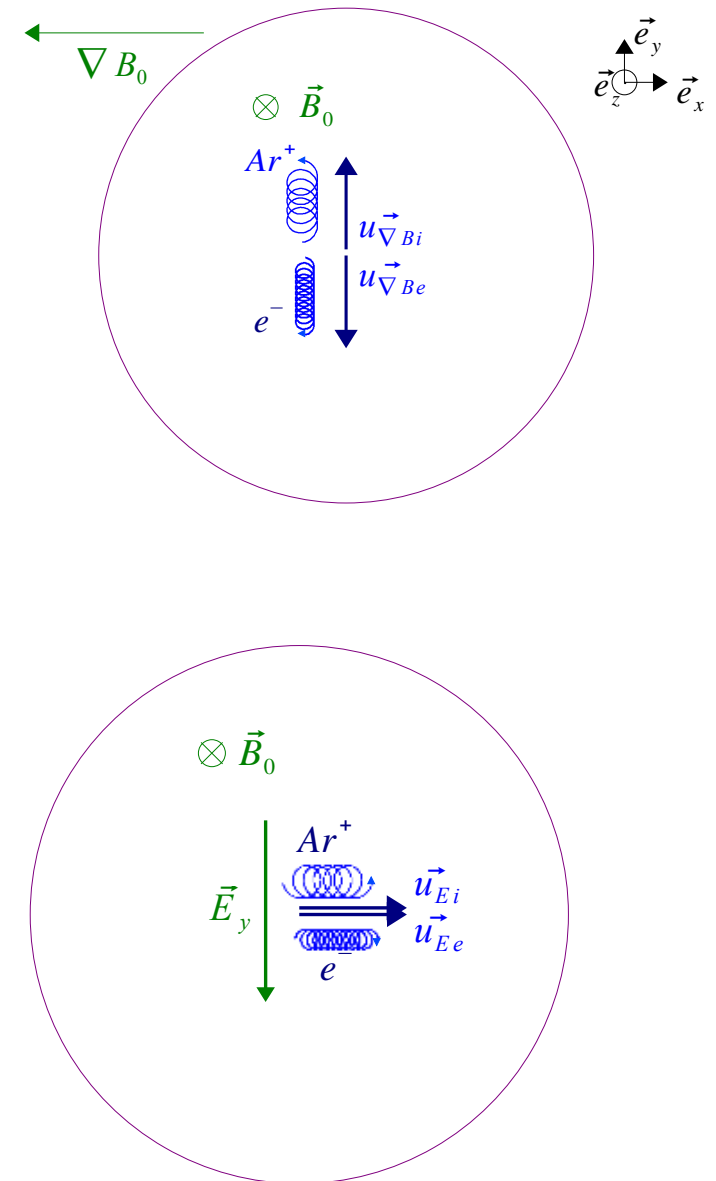

Helical magnetic field lines

Poloidal helicoid magnetic field line geometry is necessary to compensate the initial magnetic field gradient and curvature drifts.

For Torix an additional magnetic field component is added:

- since charged particles are free to move along the magnetic field lines, they can **compensate part of the charge separation**: the secondary drift is reduced;
- the magnetic field lines are then open; **charged particles can move to the edge**.

For small vertical magnetic field component, the 1st effect is the main one.

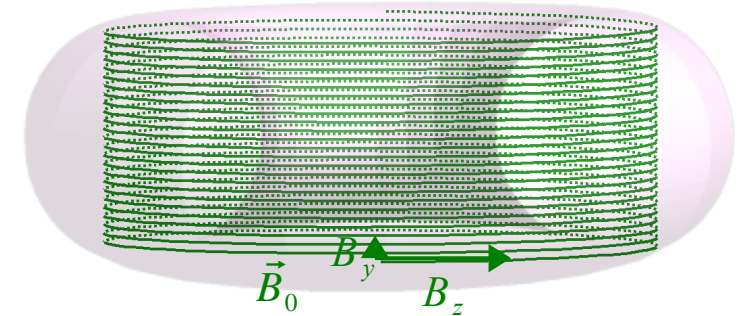
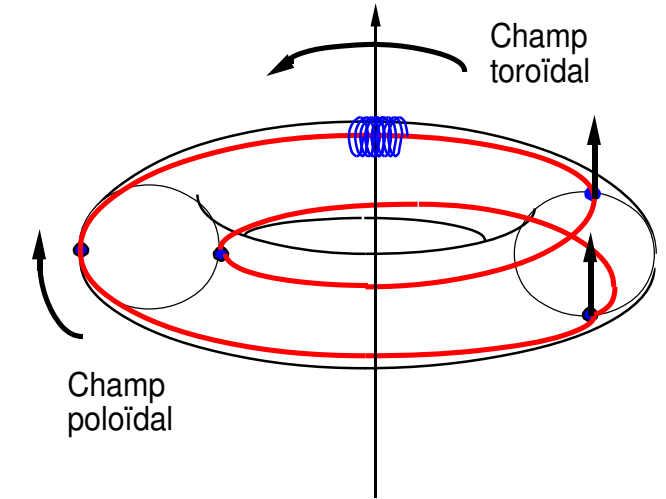

Polarized filament

Plasma is created by a hot polarized (negative potential -90 V) filament that emits primary electron inside Argon gas. The energetic primary electrons ionize part of the argon atoms.

The negative potential in the center of the torus due to the filament implies a circular plasma $E \times B$ drift around the minimum potential

When the a additional vertical magnetic field component is present, the potential is more uniform vertically. $E \times B$ drifts are mainly vertical.

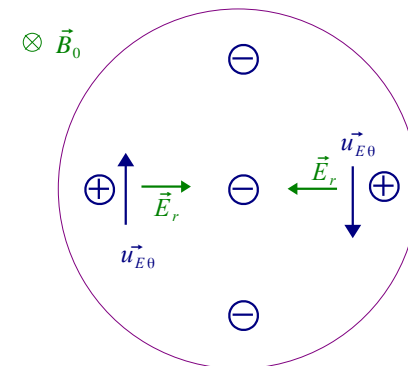
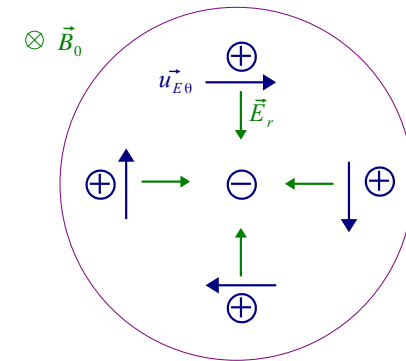
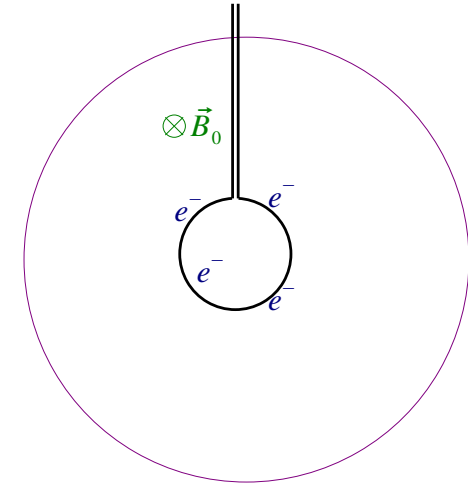

Torix parameters

Torix : toric magnetized plasma

Large radius : $R = 61 \text{ cm}$

Small radius : $a = 10 \text{ cm}$

- 12 coils around the torus to create the main toroidal magnetic field $I \sim 1 \text{ kA}$
- 2 horizontal coils in Helmholtz configuration, to add a small vertical magnetic field component

$$\vec{B}_\varphi \leq 0,4 \text{ T} \quad \vec{B}_v \leq 1 \text{ mT}$$

Cold magnetized plasma typical parameters :

Neutral gas : Argon $n_{Ar} \sim 10^{19} \text{ m}^{-3}$

Ionization : $n_e \sim 10^{17} \text{ m}^{-3}$

Electron heating : $k_B T_e \sim 2 \text{ eV}$

Ion temperature : $k_B T_{Ar^+} = 0,03 \text{ eV}$

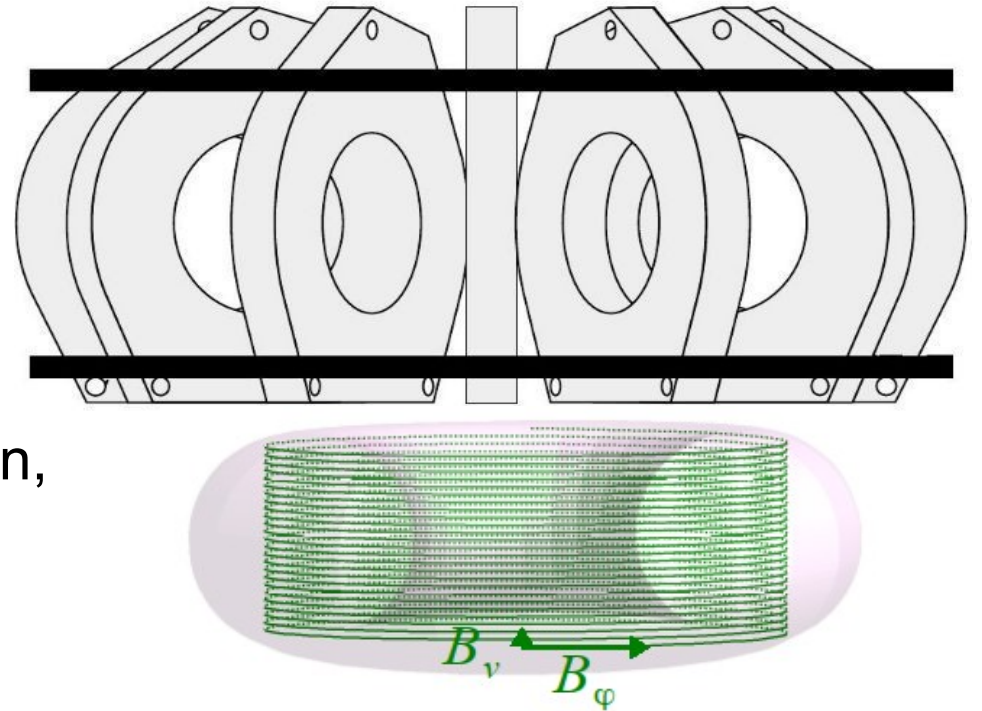

Drift wave instabilities

Diamagnetic drift velocity

Drift wave main

Diamagnetic drift

Charged particle velocity distribution with a density or a temperature gradient

Particle position: x

Center guide position: $X = x + \frac{v_y}{\omega_{c\alpha}}$

Density and Temperature depend on X :

$$T_\alpha(X) \quad n_{g\alpha}(X)$$

Center guide velocity distribution as a function of X :

$$f_{g\alpha}(X, \vec{v}) = \left(\frac{m_\alpha}{2\pi k_B T_\alpha(X)} \right)^{3/2} n_{g\alpha}(X) e^{-\frac{m_\alpha v^2}{2k_B T_\alpha(X)}} \quad (\text{Boltzmann})$$

Particle velocity distribution as a function of x :

$$f_{0\alpha}(x, \vec{v}) = f_{g\alpha}\left(x + \frac{v_y}{\omega_{c\alpha}}, \vec{v}\right) = f_{g\alpha}(x, \vec{v}) + \partial_X f_{g\alpha}(x, \vec{v}) \frac{v_y}{\omega_{c\alpha}}$$

with :

$$\partial_x f_{g\alpha}(x, \vec{v}) = \left[d_X \ln(n_{g\alpha}) + d_X \ln(T_\alpha) \left(\frac{\frac{1}{2} m_\alpha v^2}{k_B T_\alpha} - \frac{3}{2} \right) \right] f_{g\alpha}(x, \vec{v})$$

For density : $n_{0\alpha}(x) = n_{g\alpha}(x)$

For mean velocity : $\langle \vec{v}_{0\alpha}(x) \rangle = \left[d_X \ln(n_{0\alpha}) + d_X \ln(T_\alpha) \right] \frac{k_B T_\alpha}{q_\alpha B} \vec{e}_y$

$$\vec{u}_{P\alpha} = \frac{-\gamma_\alpha k_B T_\alpha}{q_\alpha B_0} \frac{\vec{\nabla} P_\alpha}{P_\alpha} \times \frac{\vec{B}_0}{B_0}$$

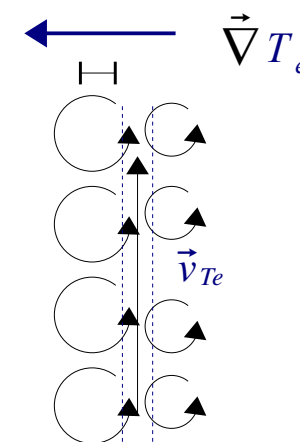
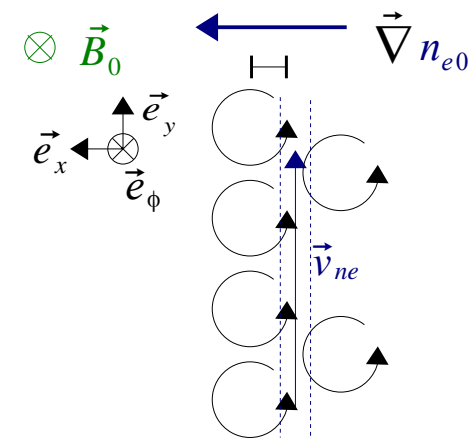

Drift wave : mode propagation

Wave describe as a perturbation

0th order plasma is a magnetized plasma with a density gradient.

1st order describe a Fourier mode in the direction perpendicular to the magnetic field and the density gradient.

Electron are supposed to be adiabatic:

$$n_{e0} + n_{e1} = n_{e0} e^{\frac{q_e \varphi_1}{k_B T_e}}$$

For small perturbations:

$$n_{e1} = \frac{q_e \varphi_1}{k_B T_e} n_{e0}$$

Plasma potential perturbations are directly proportional to density perturbations:

$$\varphi_1 = \frac{k_B T_e}{q_e n_{e0}} n_{e1}$$

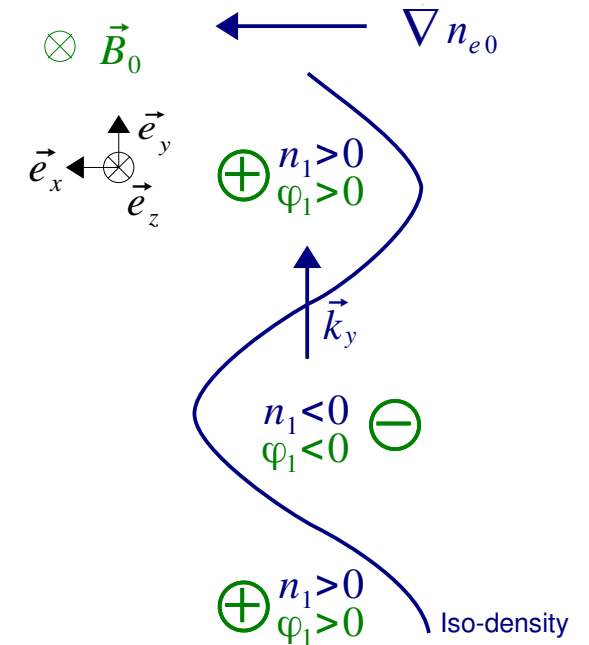

Drift wave : mode propagation

Ions are following the perturbation ExB drift:

$$u_{ix1} = -i k_y \frac{\varphi_1}{B_{z0}}$$

Ion mass conservation:

$$-i\omega n_{e1} + u_{ix1} \partial_x n_{e0} = 0$$

Combining both gives a second relation between

n_{e1} and φ_1 :

$$\omega n_{e1} = -k_y \frac{\varphi_1}{B_{z0}} \partial_x n_{e0}$$

$$\varphi_1 = \frac{k_B T_e}{q_e n_{e0}} n_{e1}$$

Combining both expressions between n_{e1} and φ_1 so that both parameters compensate gives the dispersion relation:

$$\omega = -k_y \frac{k_B T_e}{q_e B_{z0}} \frac{\partial_x n_{e0}}{n_{e0}}$$

The phase relation gives the diamagnetic velocity:

$$\vec{u}_\phi = \vec{u}_{ne} = \frac{k_B T_e}{n_e q_e B_{z0}^2} \vec{\nabla} n_e \times \vec{B}$$

If there is an additional global ExB drift, the phase

velocity is: $\vec{u}_\phi = \vec{u}_{ne} + \vec{u}_{ExB}$

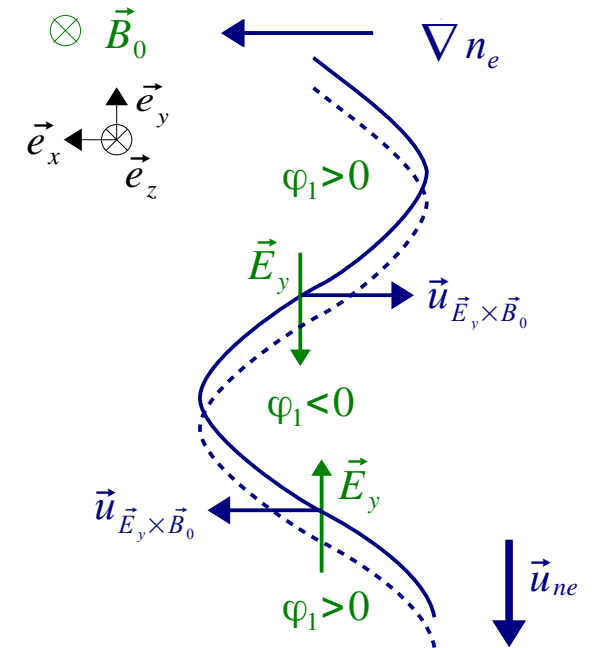

Dynamic probe measurements

Radially moving Langmuir probes

The radially moving Langmuir probe arm allows plasma parameter radial profile measurements.

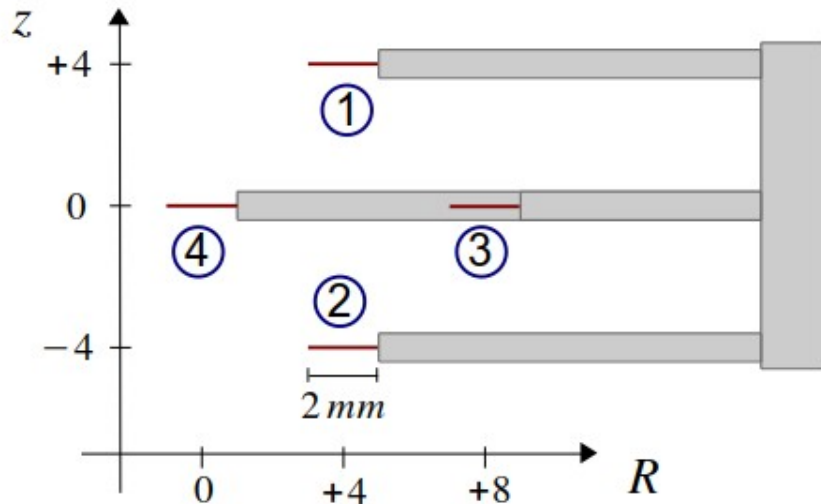
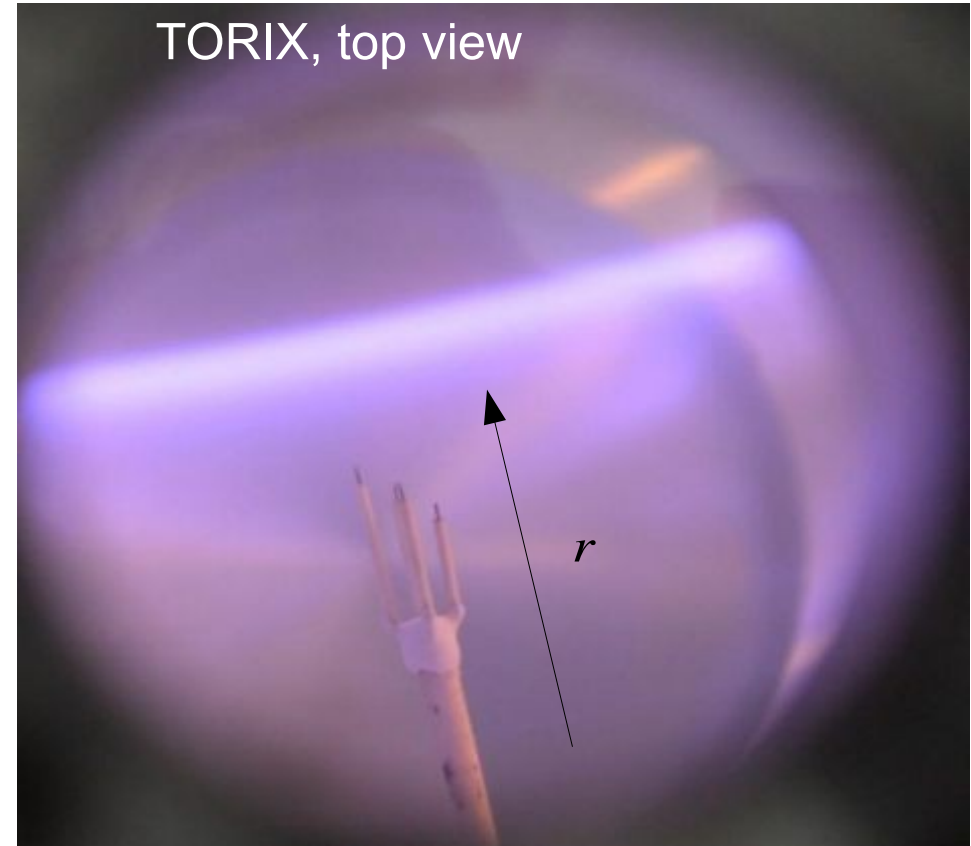
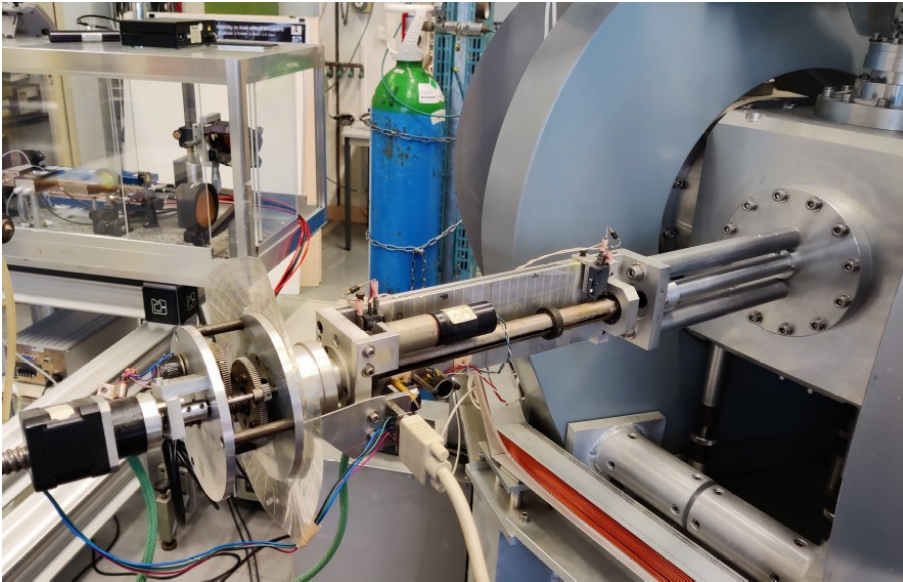

Multiple probes allows to study the instability spatial properties.

Probe polarization and current acquisition

Probe current measurements are difficult
We have to subtract measurement without plasma from measurement with plasma to compensate the electronic bias in measurement and the capacitive effect of the probe on the circuit.

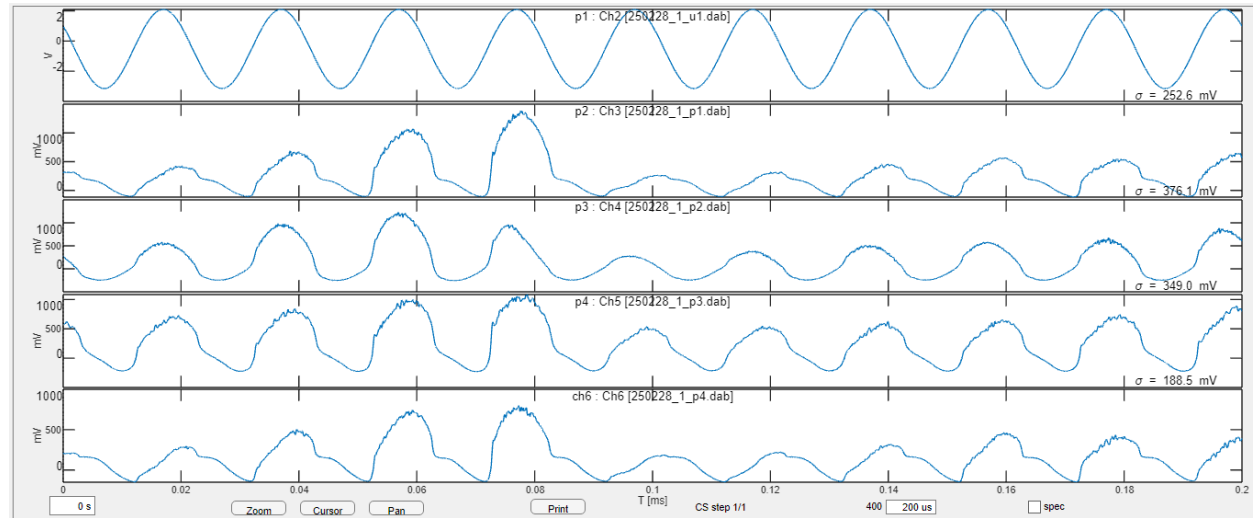

Probe current measurements with plasma

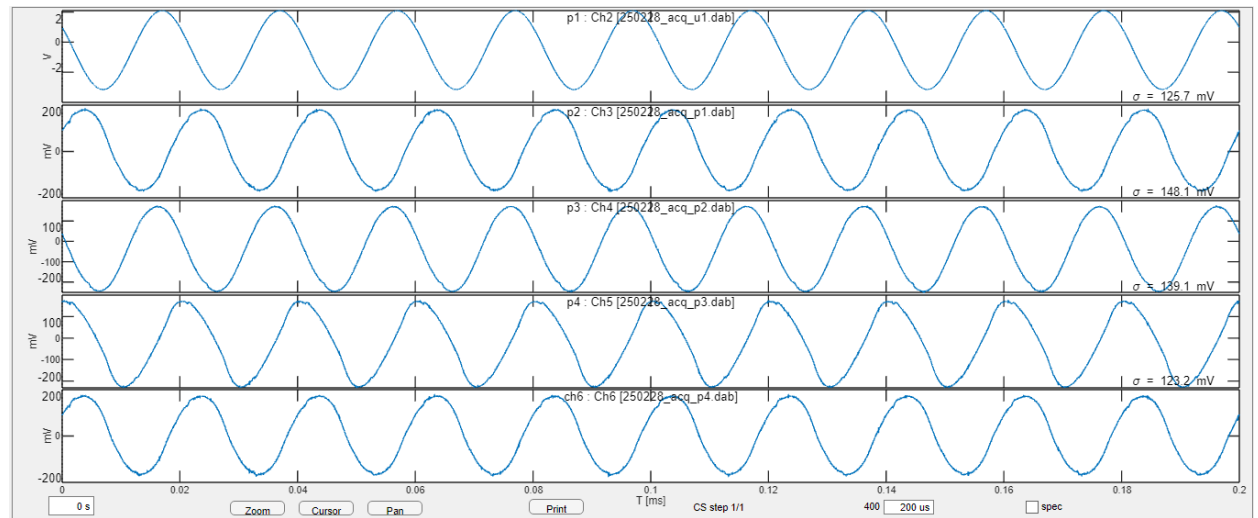

Probe current measurements without plasma

100 kHz probe dynamical measurements

Dynamical measurements are possible.

Taking into account the delay between probe generator potential and probe current measurements, the probe characteristics show no hysteresis between probe potential increasing and decreasing phases.

Generator is at 50 kHz, but 2 plasma parameter extractions are possible for each generator period

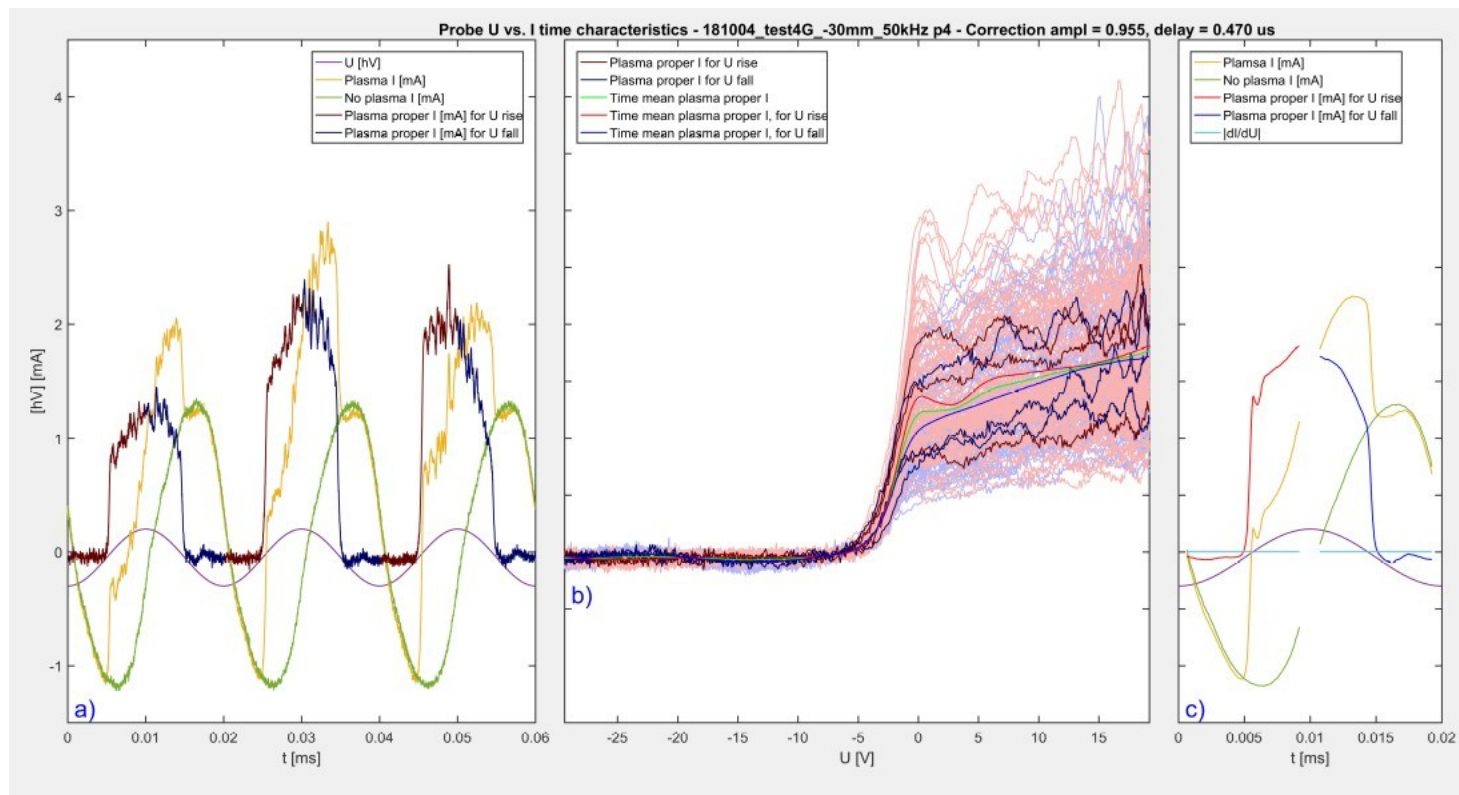

100 kHz probe dynamical measurements

Electronic development :

50 kHz dynamic probe polarization and probe current measurements.

Data treatment to extract plasma parameter time signals.

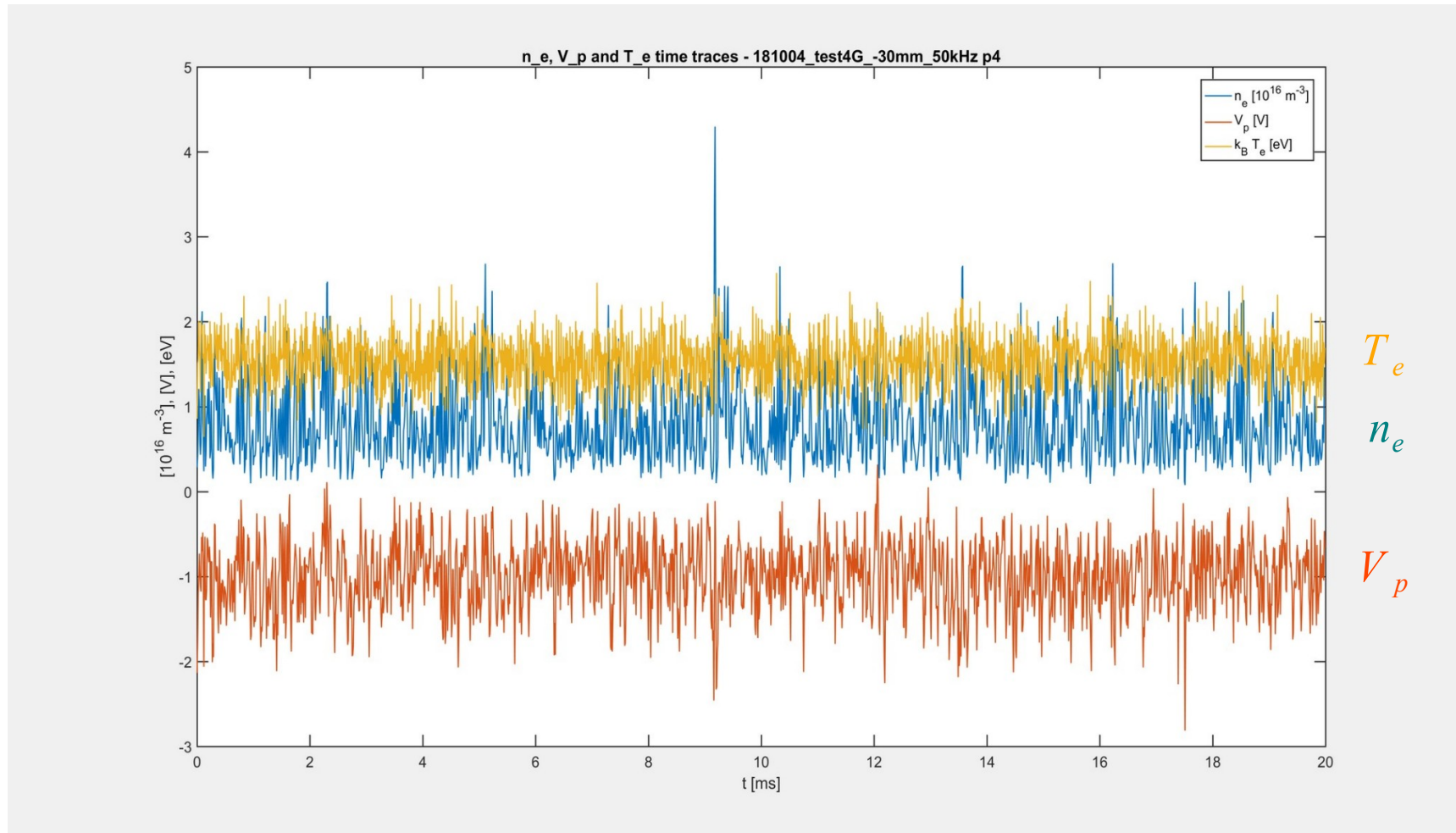

High speed camera measurements

High speed camera

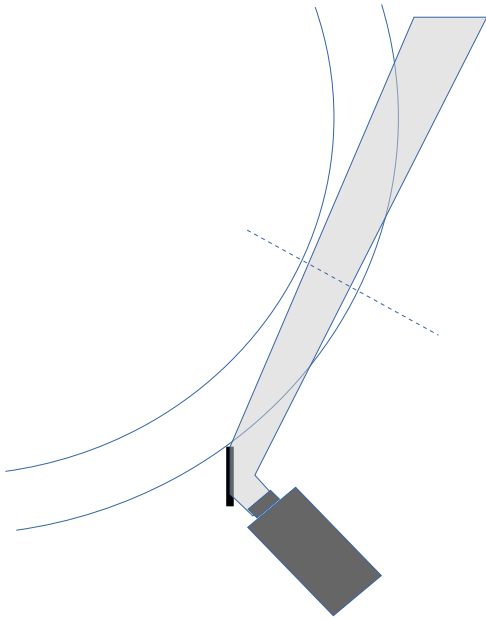

A high speed camera observes the plasma in front of a Torix quartz window.

A mirror is placed right behind the window to give a tangential view to the camera. The focal position is 90 cm in front of the camera lens. This corresponds to the position where the observation direction is tangential to the magnetized plasma.

Toric geometry

The plasma produces light and is transparent.
It is seen as a 3D object.

The light received by each pixel of the camera corresponds to light emitted by the plasma along a chord.

We can use the plasma that plasma parameters are mainly uniform along the magnetic field lines : the plasma is quasi-axisymmetric.

Abel Inversion helps to get light emission local values

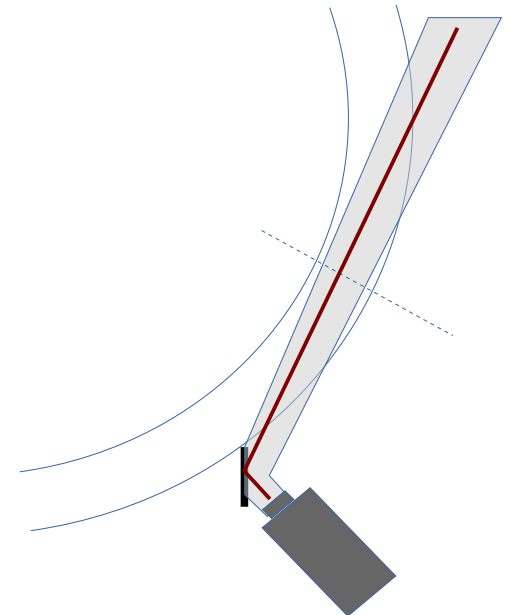
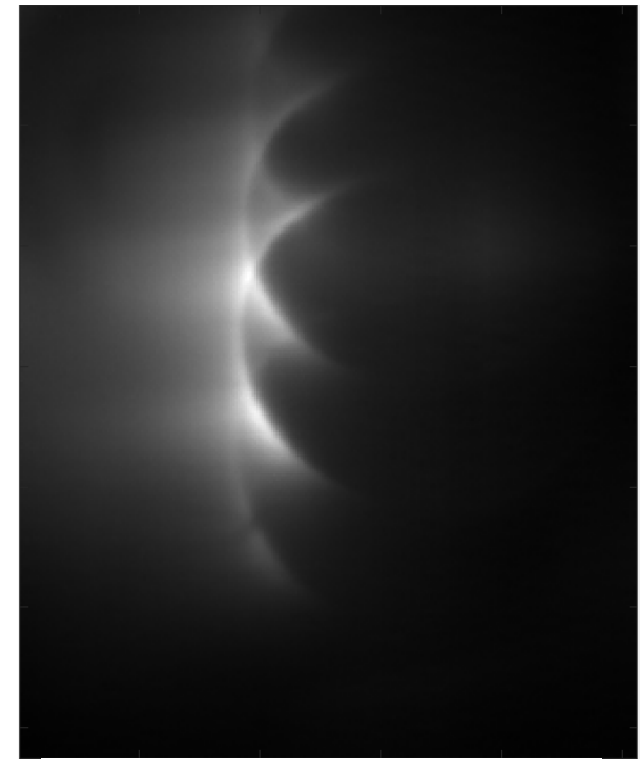

Camera image Abel inversion

Abel inversion for each plasma vertical slice

f_2 : 2D local plasma emission

F : pixel integrated light (along a plasma chord)

$$F(y) = 2 \int_0^{+\infty} f_2(x, y) dx$$

$f(R)$: because of plasma axisymmetry the local plasma emission is only a function a tore large Radius :

$$f_2(x, y) = f(\sqrt{x^2 + y^2}) \quad R = \sqrt{x^2 + y^2}$$

Expression of the integrated using the radial function:

$$F(y) = 2 \int_y^{+\infty} \frac{R f(R)}{\sqrt{R^2 - y^2}} dR$$

Abel inversion gives the expression of the radial function from the integrated function:

$$f(R) = -\frac{1}{\pi} \int_R^{+\infty} \frac{1}{\sqrt{y^2 - R^2}} \frac{dF(y)}{dy} dy$$

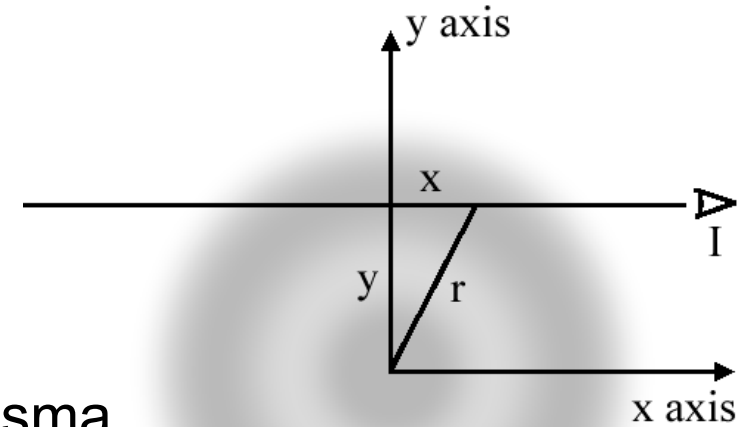
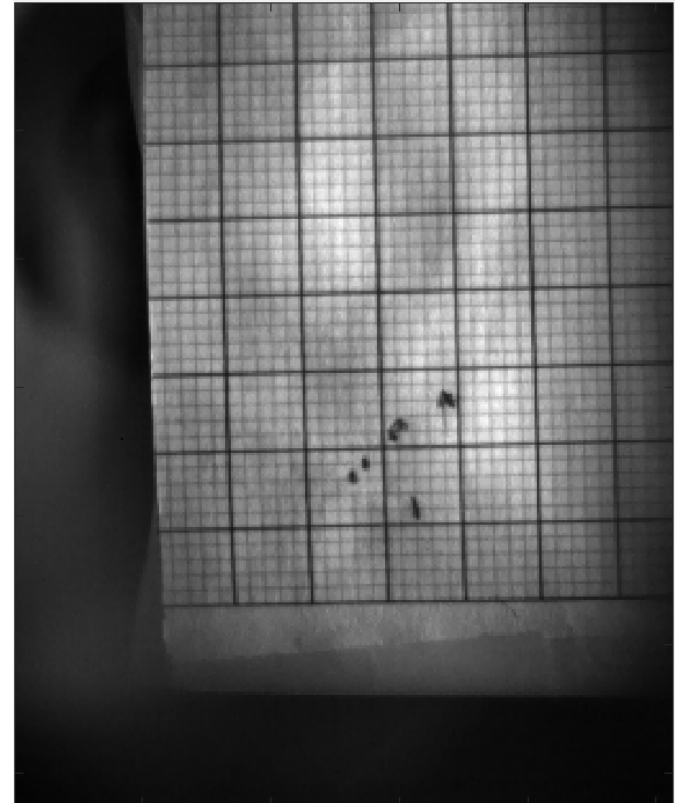

Image calibration

In order to do the Abel Inversion, we must translate horizontal pixel to the large radius. First we must determine the ratio mm/px

We use a calibration grid placed where the camera observation angle is perpendicular to the radius.

The **bold** grid has a 9.6 mm step



Toric geometry

We must find a reference position.
We suppose the light maximum position corresponds to the density maximum position.

We first have to find the probe height.

We have to look at the difference between the mean image with the probe outside (+52 mm) and the mean image with the probe inside (-36 mm) making a shadow on the plasma

